

E2003H00-NP X-XX-XX  
① ② ③ ④

- ① No. of Circuits
- ② X : Product color(A--Y)  
A : Black type  
Blank : White
- ③ HF : Halogen Free  
Blank : Rohs
- ④ NK : No Mark  
Blank : Mark

◆ SPECIFICATIONS

- Current rating: 2A AC, DC
- Voltage rating: 250V AC,DC
- Temperature range: -25°C ~ +85°C
- Insulation resistance: 1000MΩ Min.
- Withstanding voltage: 1000V AC/ minute.
- Contact resistance: 20mΩ Max.

Material:

Material: Nylon66 UL 94V-0

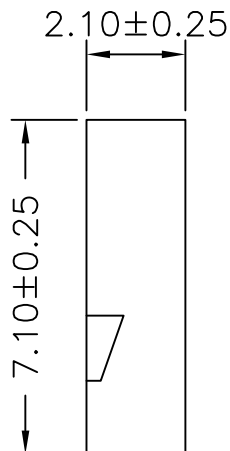
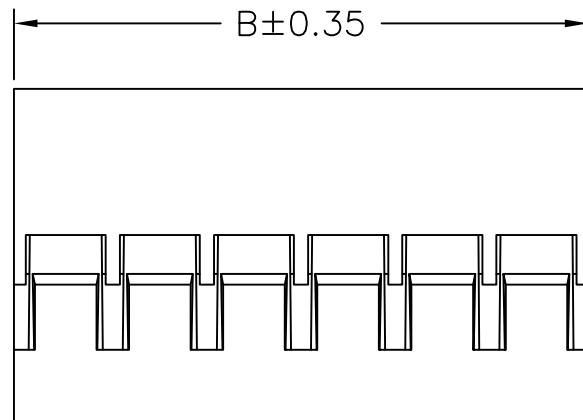

Poles	Dimensions(mm)		Poles	Dimensions(mm)	
	A	B		A	B
02	2.00	4.20	12	22.00	24.20
03	4.00	6.20	13	24.00	26.20
04	6.00	8.20	14	26.00	28.20
05	8.00	10.20	15	28.00	30.20
06	10.00	12.20	16	30.00	32.20
07	12.00	14.20	17	32.00	34.20
08	14.00	16.20	18	34.00	36.20
09	16.00	18.20	19	36.00	38.20
10	18.00	20.20	20	38.00	40.20
11	20.00	22.20	21	40.00	42.20

④				GENERAL TOLERANCE	UNIT: mm	DATE	TITLE:	
③				.X ± 0.30	X° ± 1°	DRAWN: 朱佑武	杜邦2.0 单排Housing	
②				.XX ± 0.20	.X° ±	CHECKED: 张自豪	2015.09.21	
①				.XXX ± 0.10	.XX° ±	APPROVED: 张自豪	2015.09.21	
LTR	NAME	DATE	VERSION RECORD				VER.	SCALE: N/A
1							A	SHEET: 1/1

东莞市宏欣蓝电子有限公司

PROJECTION PART NO. E2003H00-NPX-XX-XX

DRAWING NO. E2003H

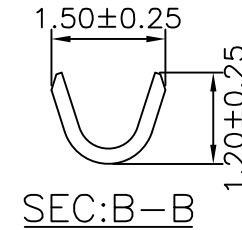
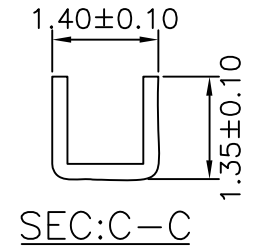
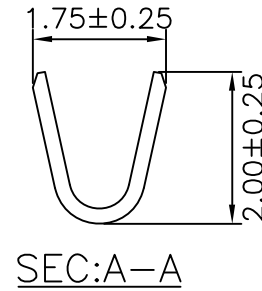
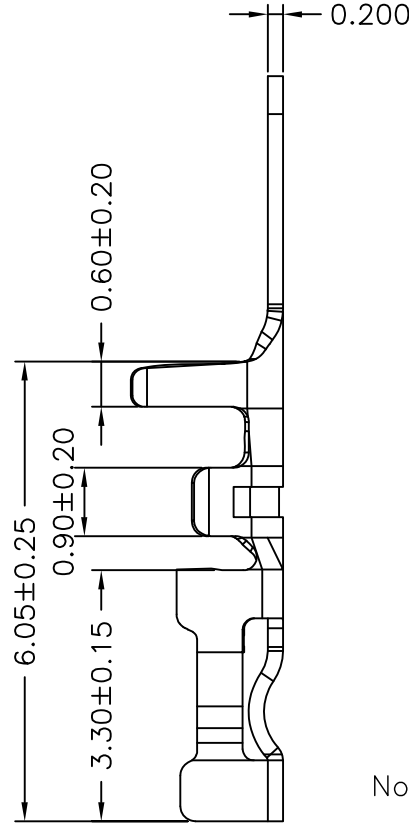
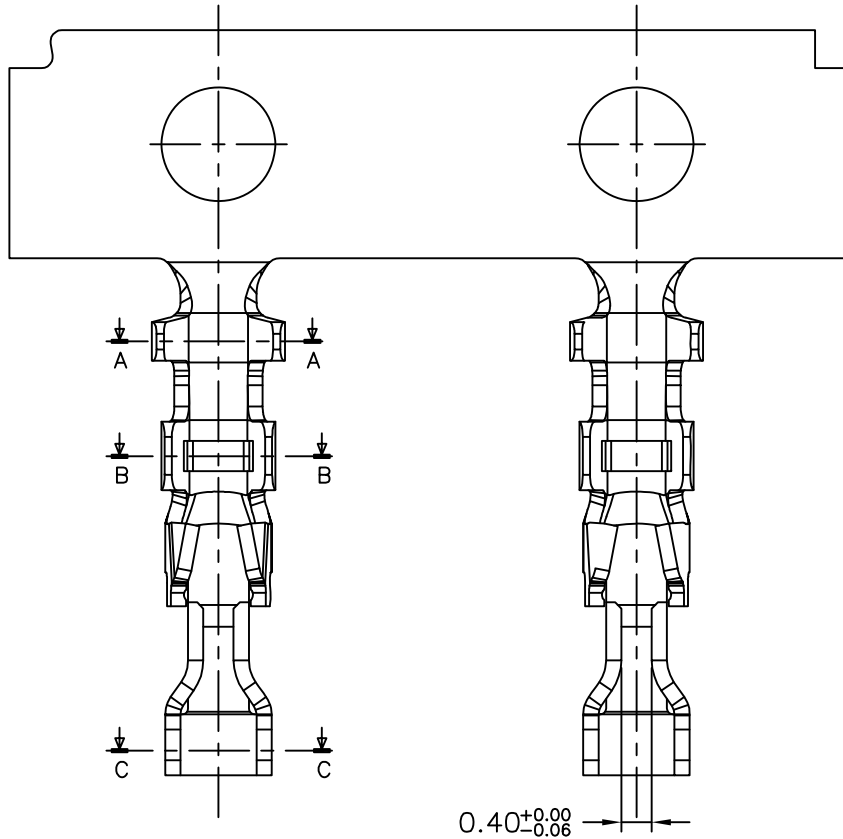

Note: E2003T0X-XX-XX

空码: Mark  
NK: No Mark

Finish  
2E--Tin-plated  
5A--Gold flash(全)  
0A--Gold flash(半)

B: Brass P: Phosphor bronze  
倾斜: 180°  
Terminal

Ordering Information & Specifications

Part No	Wire Range	Insulation O.D.	Material	Finish	Qty/reel
E2003T0X-2E-NK	AWG#26-30#	1.40mm(max)	Phosphor Bronze/Brass	Tin-plated	10,000pcs
E2003T0X-XX-NK	AWG#26-30#	1.40mm(max)	Phosphor Bronze/Brass	Gold flash	10,000pcs

GENERAL TOLERANCE				UNIT: mm		DATE		TITLE:	
④				.X ± 0.30	X° ± 1°	DRAWN:	朱佑武	2015.09.21	杜邦2.0 Terminal
③				.XX ± 0.20	.X° ±	CHECKED:	张自豪	2015.09.21	
②				.XXX ± 0.10	.XX° ±	APPROVED:	张自豪	2015.09.21	
①									
LTR	NAME	DATE	VERSION RECORD						

VER.			SCALE:		N/A		PROJECTION		PART NO.		E2003T0X-XX-XX	
A			SHEET:		1/1		DRAWING NO.		E2003T			

东莞市宏欣蓝电子有限公司