

Specifications:
 Rated Voltage : 250V AC/DC
 Rated Current : 3A AC,DC
 Contact Resistance: 10mΩ(Max.)
 Withstand Voltage : 1500V AC/minute
 Insulation Resistance : 500MΩ(MIN.)
 Temperature Range : -25°C~+85°C
 Material: Nylon 66,UL94V-0

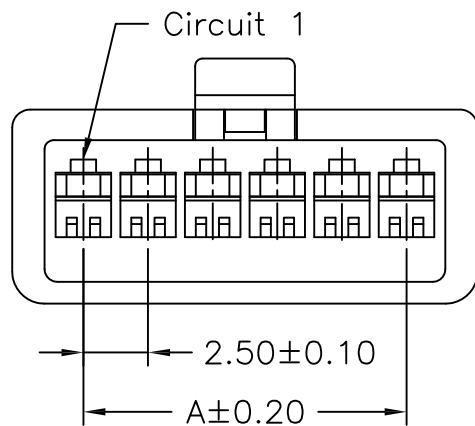

C2521HF0-NPX-XX-XX

① ② ③④ ⑤ ⑥

- ① Series No.
- ② HF0 : Female Housing
- ③ No. of Circuits
- ④ X : Product color(A--Y)
Blank: Natural type
- ⑤ HF : Halogen Free
Blank: Rohs
- ⑥ NK: No Mark
Blank: Mark

Ordering Information & Dimensions

PART NO.	Dimensions	
	A	B
C2521HF0-02P	2.50	8.00
C2521HF0-03P	5.00	10.50
C2521HF0-04P	7.50	13.00
C2521HF0-05P	10.00	15.50
C2521HF0-06P	12.50	18.00
C2521HF0-07P	15.00	20.50
C2521HF0-08P	17.50	23.00
C2521HF0-09P	20.00	25.50
C2521HF0-10P	22.50	28.00
C2521HF0-11P	25.00	30.50
C2521HF0-12P	27.50	33.00

				GENERAL TOLERANCE		UNIT: mm		DATE		TITLE:		
				.X ± 0.30		X° ± 1°		DRAWN: 张自豪 2017.09.28		SM2.5 母Housing		
				.XX ± 0.20		.X° ±		CHECKED:		VER. SCALE: N/A		
LTR NAME DATE VERISION RECORD				.XXX ± 0.10		.XX° ±		APPROVED:		PROJECT PART NO. C2521HF0-NPX-XX-XX		
										DRAWING NO. C2521HF		

东莞市宏欣蓝电子有限公司

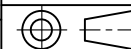

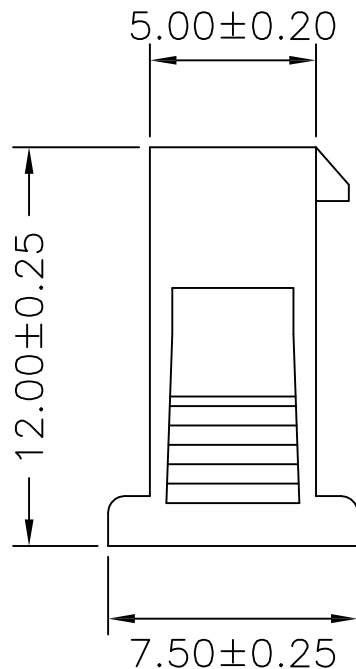
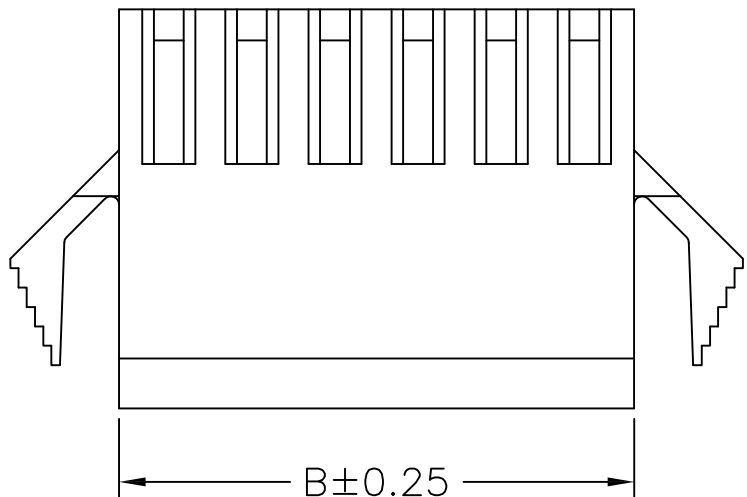

Specifications:
 Rated Voltage : 250V AC/DC
 Rated Current : 3A AC,DC
 Contact Resistance: 10mΩ(Max.)
 Withstand Voltage : 1500V AC/minute
 Insulation Resistance : 500MΩ(MIN.)
 Temperature Range : -25°C~+85°C
 Material: Nylon 66,UL94V-0

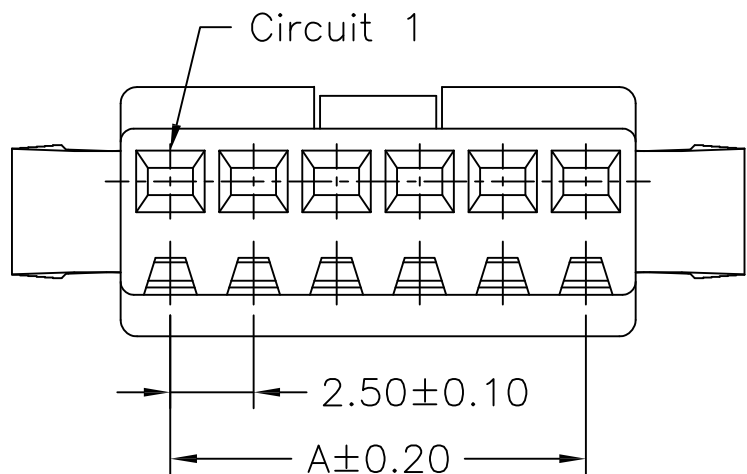

C2521HM0-NPX-XX-XX

① ② ③④⑤ ⑥

- ① Series No.
- ② HM0 : Male Housing
- ③ No. of Circuits
- ④ X : Product color(A--Y)
Blank: Natural type
- ⑤ HF : Halogen Free
Blank: Rohs
- ⑥ NK: No Mark
Blank: Mark

Ordering Information & Dimensions

PART NO.	Dimensions	
	A	B
C2521HM0-02P	2.50	5.50
C2521HM0-03P	5.00	8.00
C2521HM0-04P	7.50	10.50
C2521HM0-05P	10.00	13.00
C2521HM0-06P	12.50	15.50
C2521HM0-07P	15.00	18.00
C2521HM0-08P	17.50	20.50
C2521HM0-09P	20.00	23.00
C2521HM0-10P	22.50	25.50
C2521HM0-11P	25.00	28.00
C2521HM0-12P	27.50	30.50

				GENERAL TOLERANCE		UNIT: mm		DATE		TITLE:		
				.X±0.30 X°±1°		DRAWN: 张自豪		2017.09.28		SM2.5 公Housing		
				.XX±0.20 .X°±		CHECKED:				VER. SCALE: N/A		
LTR NAME DATE VERISION RECORD				.XXX±0.10 .XX°±		APPROVED:				PROJECT PART NO. C2521HM0-NPX-XX-XX		
										DRAWING NO. C2521HM		
1	2	3	4	5	6	7	8	9				

东莞市宏欣蓝电子有限公司

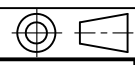

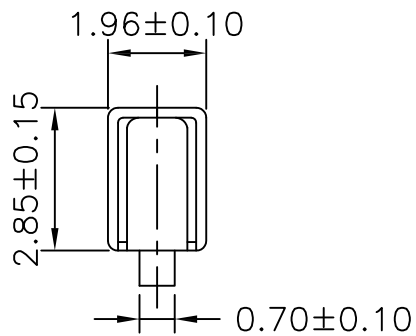
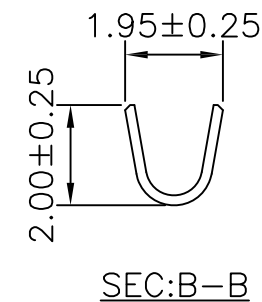
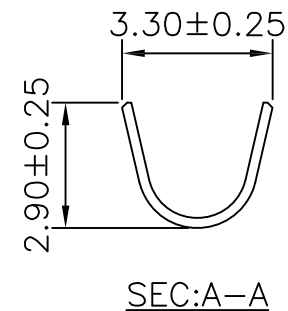
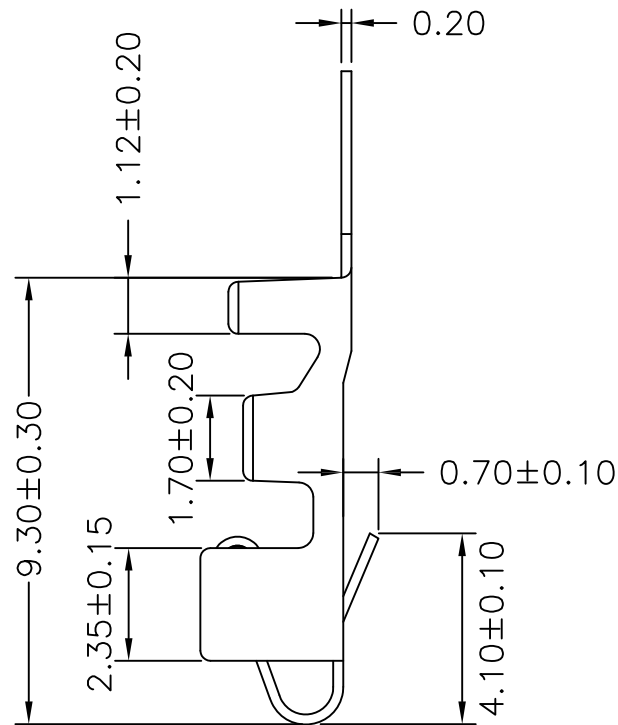
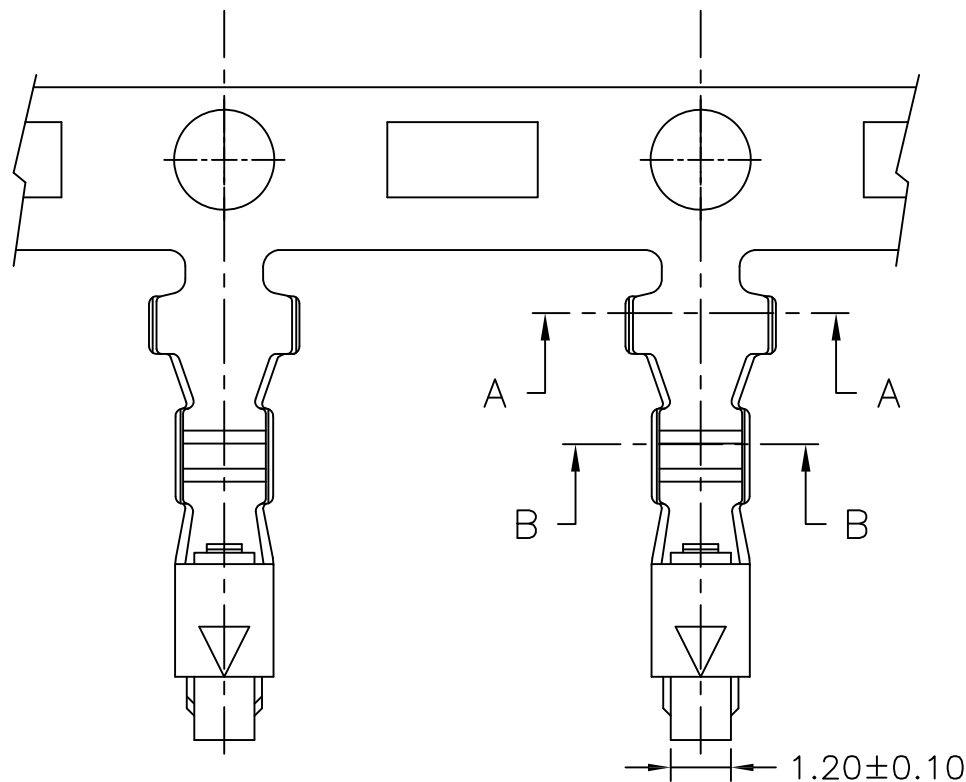

Specifications & Ordering Information:

Part No	Wire Range	Insulation O.D.	Material	Finish	Qty/reel
C2521TFP-2E-NK	AWG#22~#28	1.80mm(max)	Phosphor Bronze	Tin-Plated	5,000 PCS

			GENERAL TOLERANCE		UNIT: mm		DATE		TITLE:			东莞市宏欣蓝电子有限公司					
			.X ± 0.30	X° ± 1°	DRAWN: 张自豪		2017.10.15		SM2.5 母Terminal								
			.XX ± 0.20	.X° ±	CHECKED:				VER.		SCALE: N/A		PROJECT		PART NO. C2521TFP-2E-NK		
LTR			NAME		DATE		VERISION RECORD			.XXX ± 0.10		.XX° ±		APPROVED:		DRAWING NO. C2521TF	

1 2 3 4 5 6 7 8 9

A

A

B

B

C

C

D

D

E

F

F

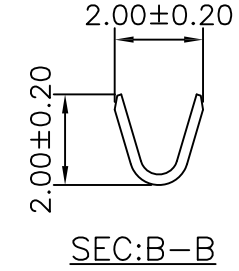
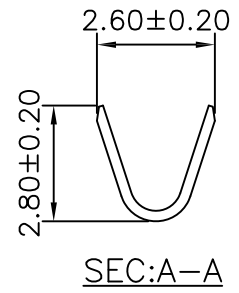
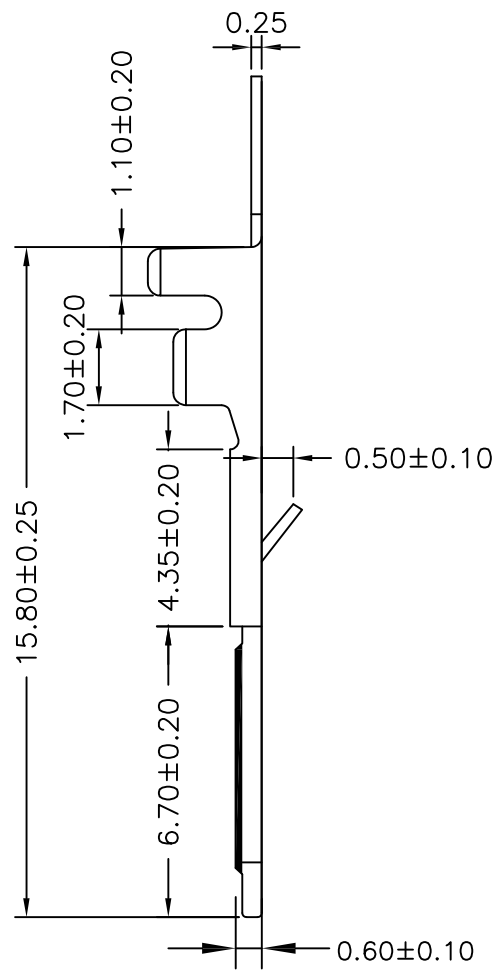
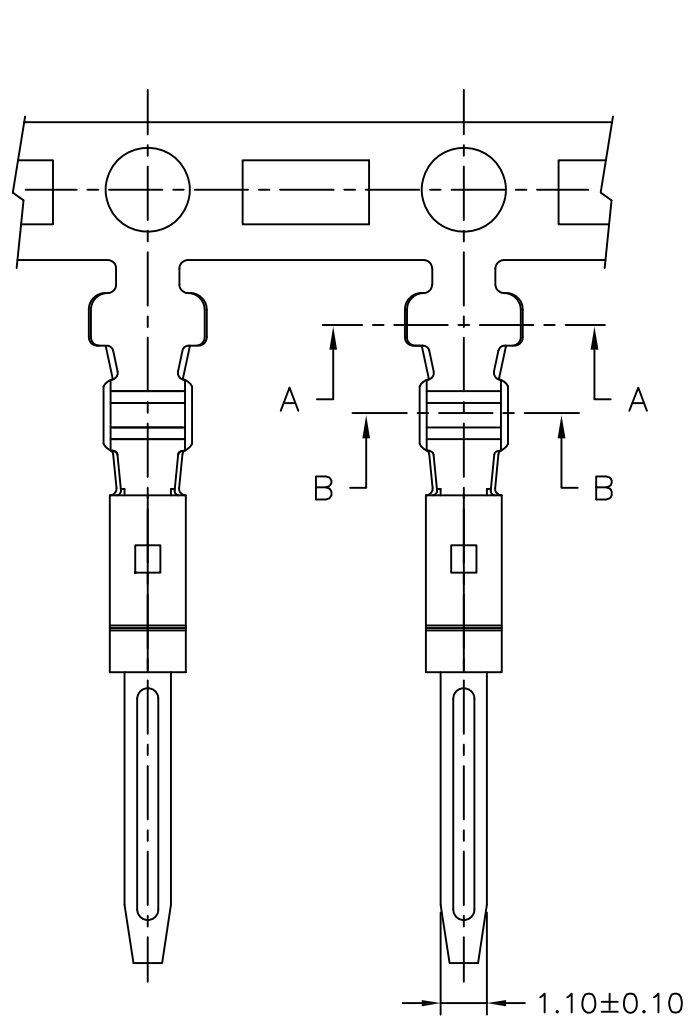

Specifications & Ordering Information:

Part No	Wire Range	Insulation O.D.	Material	Finish	Qty/reel
C2521TMP-2E-NK	AWG#22~#28	1.80mm(max)	Phosphor Bronze	Tin-Plated	10,000PCS

				GENERAL TOLERANCE	UNIT: mm	DATE	TITLE:			东莞市宏欣蓝电子有限公司		
				.X ± 0.30	X° ± 1°	DRAWN: 张自豪	SM2.5 公 Terminal					
				.XX ± 0.20	.X° ±	CHECKED:	VER. SCALE: N/A			PROJECT	PART NO.	C2521TMP-2E-NK
LTR	NAME	DATE	VERSION RECORD	.XXX ± 0.10	.XX° ±	APPROVED:	A0	SHEET: 1/1	DRAWING NO.		C2521TM	

1 2 3 4 5 6 7 8 9